



Bundesministerium
für Bildung
und Forschung

TERENO
TERRESTRIAL ENVIRONMENTAL OBSERVATORIES



Remote Sensing for Environmental Applications

Irena Hajsek & Members of CT Environmental Sensing

German Aerospace Center, Microwaves and Radar Institute

ETH, Institute of Environmental Engineering





Methodological Approach of CT Environmental Sensing

The following tasks will be performed in the CT:

- Collection and coordination of requirements from different CT's
- Coordination of flights and instruments over regions of interest
- Coordination of common instrument operation over regions of interest
- Intercomparison of field instruments
- Coordination of airborne/spaceborne data acquisition with ground measurements
- Reporting on data processing status and data quality
- Exchange of inversion procedures for the environmental parameters
- Synergies between different sensors
- Collection, coordination, archiving of different types of data

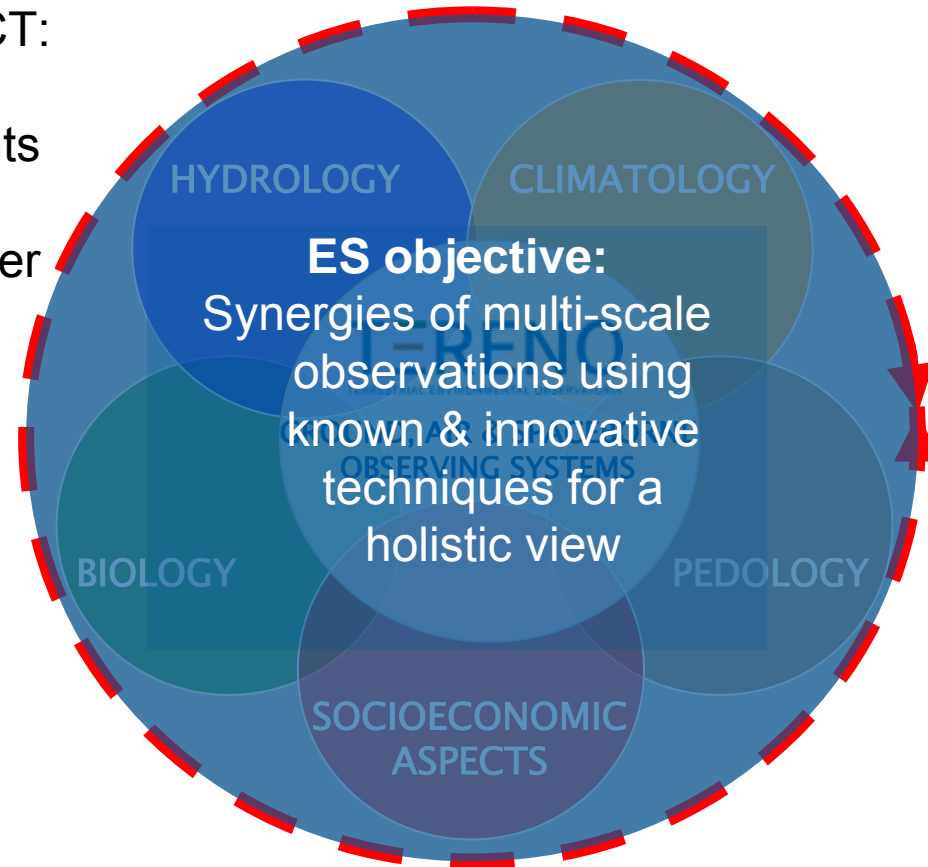



Environmental Sensing from Air and Space

Airborne measurements

- Highly flexible operation
- Coverage of dedicated areas
- Experimental configuration
- Sensor specific data formats
- Short re-visit times

Spaceborne measurements

- Highly regular observation
- Wide area coverage
- Highly operational & reliable
- Standard product delivery
- Long term observations

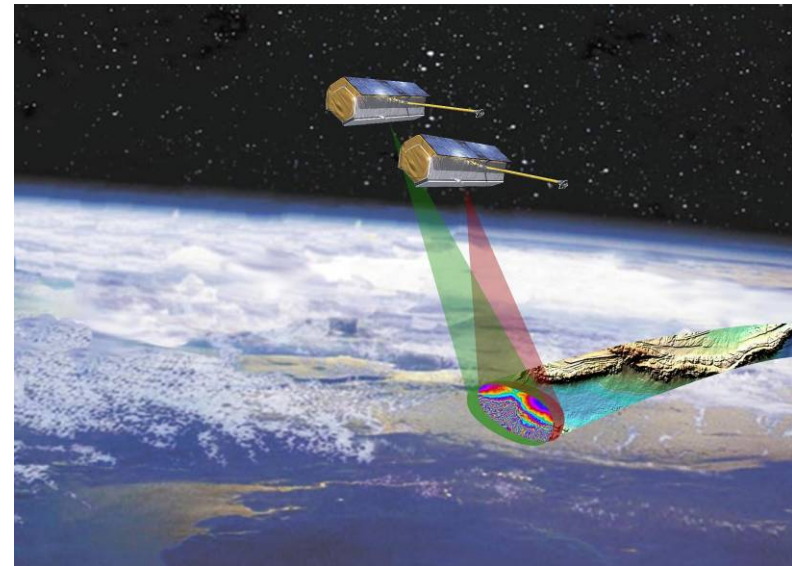



Contribution & Interest from different Research Centers

Research Institution	Optic	SAR	Radiometry
<i>German Aerospace Center Microwaves and Radar Inst.; Earth Observation Center</i>	<i>Hyperspectral Sensors</i>	<i>F-SAR TerraSAR-X TanDEM-X</i>	---
<i>UFZ Helmholtz Center for Environmental Research</i>	<i>Hyperspectral Sensors</i>	---	---
<i>Forschungszentrum Jülich GmbH Agrosphere Institute (IBG 3)</i>	---	---	<i>PLMR/PLMR2 EMIRAD-2 HUT-2D (ELBARA)</i>
<i>Karlsruhe Institute of Technology</i>	<i>Thermal Infrared Camera</i>	---	---
<i>Helmholtz Center Potsdam - German Research Center for Geosciences</i>	<i>Hyperspectral Sensors</i>	---	---



SAR data processing

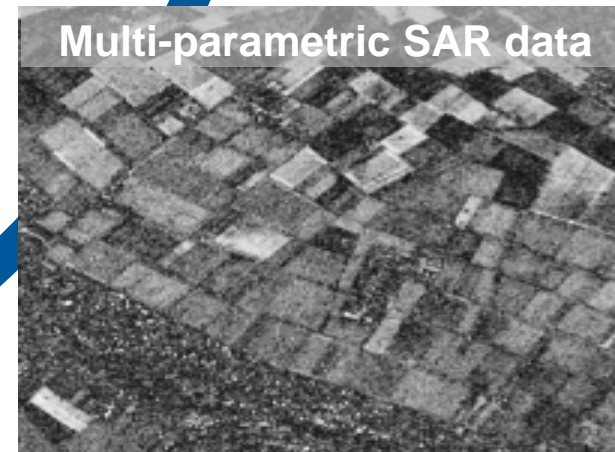

Modelling & Inversion

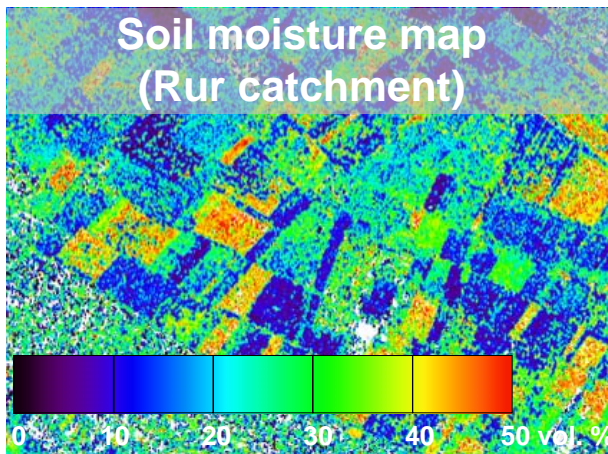

DLR (HR) - Soil Moisture from SAR

Derivation of soil moisture from multi-parametric SAR data:

- SAR data acquisition (campaign planning, campaign execution)
- SAR data processing (transcription, processing, flight reconstruction)
- Physical parameter estimation (model application, multi-parametric SAR data inversion, geocoding)



DLR (EOC) - Intercomparison of Field Instruments

- Access to optical lab infrastructure (*CHB, Calibration Home Base*) at DLR Oberpfaffenhofen
- Scientific support: Instrument characterisation, calibration (models, procedures, measurement techniques, data evaluation/interpretation)

Recent activity:

Intercomparison campaign, 2.-5.11.2010

- Sensors: 8 field spectrometers
- TERENO Partners: GFZ, UFZ, FZJ, DLR
- Radiometric & spectral characterisation, performance comparison

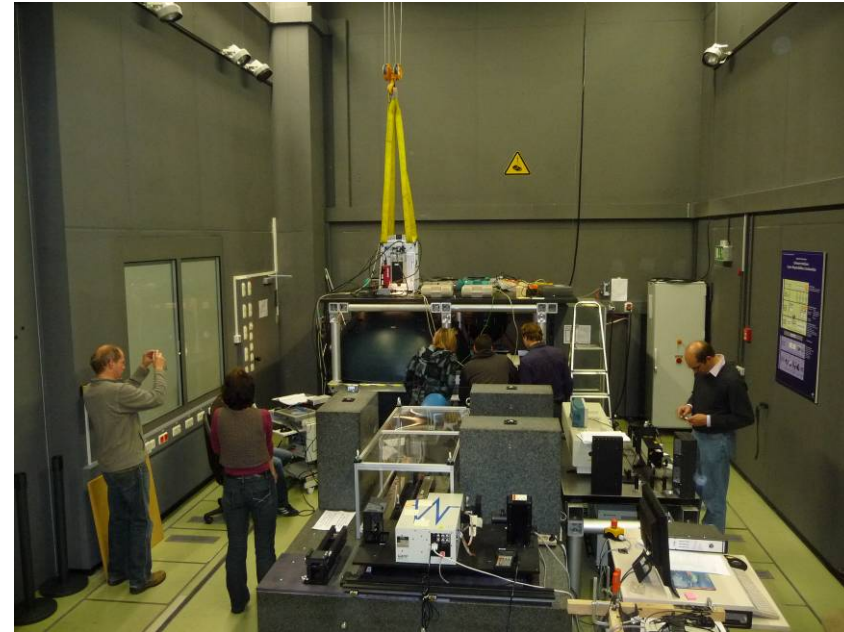



UFZ - Scale-Specific Remote Sensing

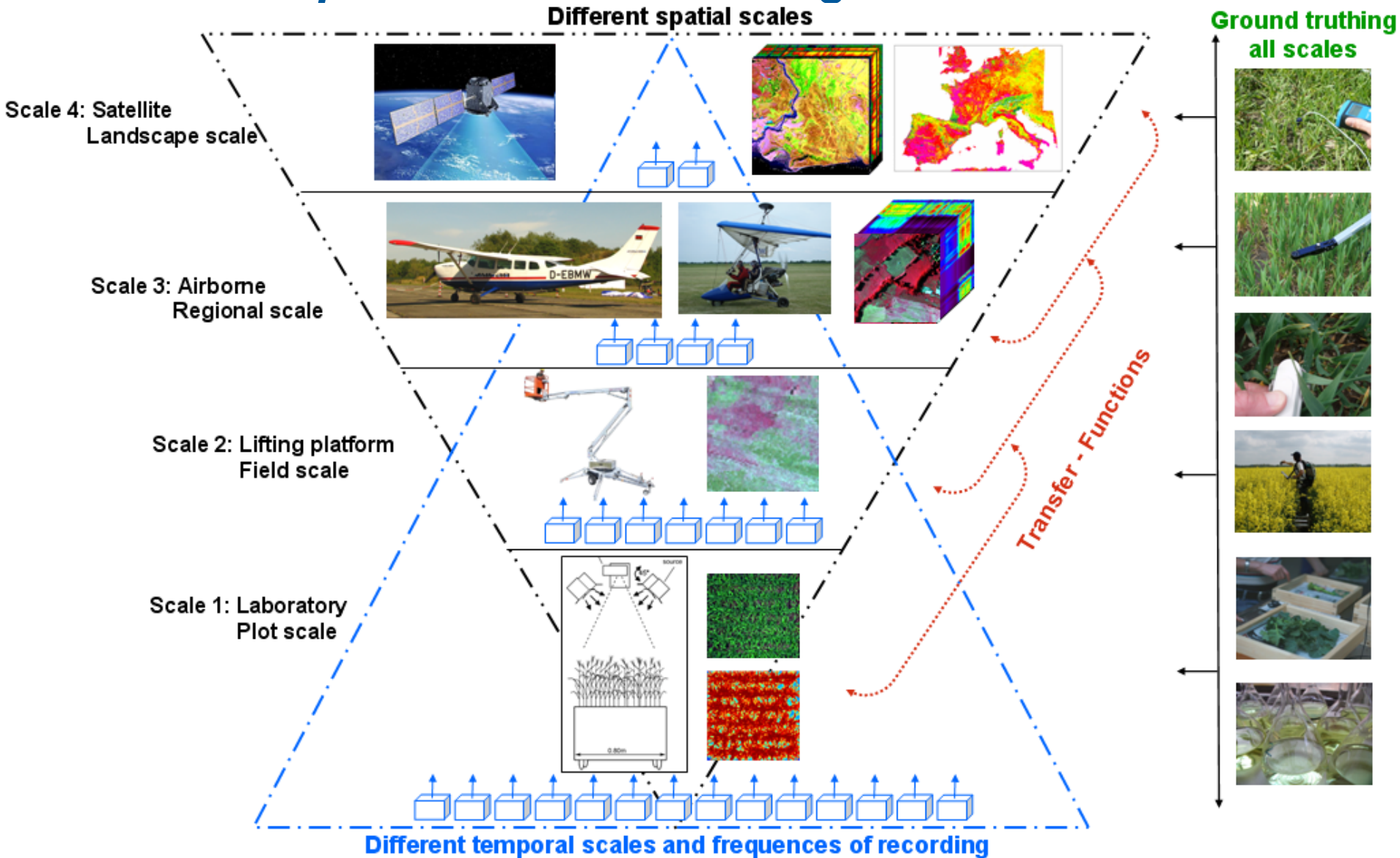



FZJ - Airborne Microwave Sensor Recordings

Brightness Temperatures



EMIRAD
(TU Denmark)



PLMR/PLMR2
(MU Melbourne/IBG 3)



HUT-2D
(Aalto Uni Helsinki)



E-SAR
(DLR)

IBG 3 focuses on the investigation of soil moisture patterns with passive and active L-band microwave systems



KIT – Product Derivation with Thermal Infrared

Thermal infrared imaging products

- Soil temperature impact on turbulent fluxes / boundary layer structure

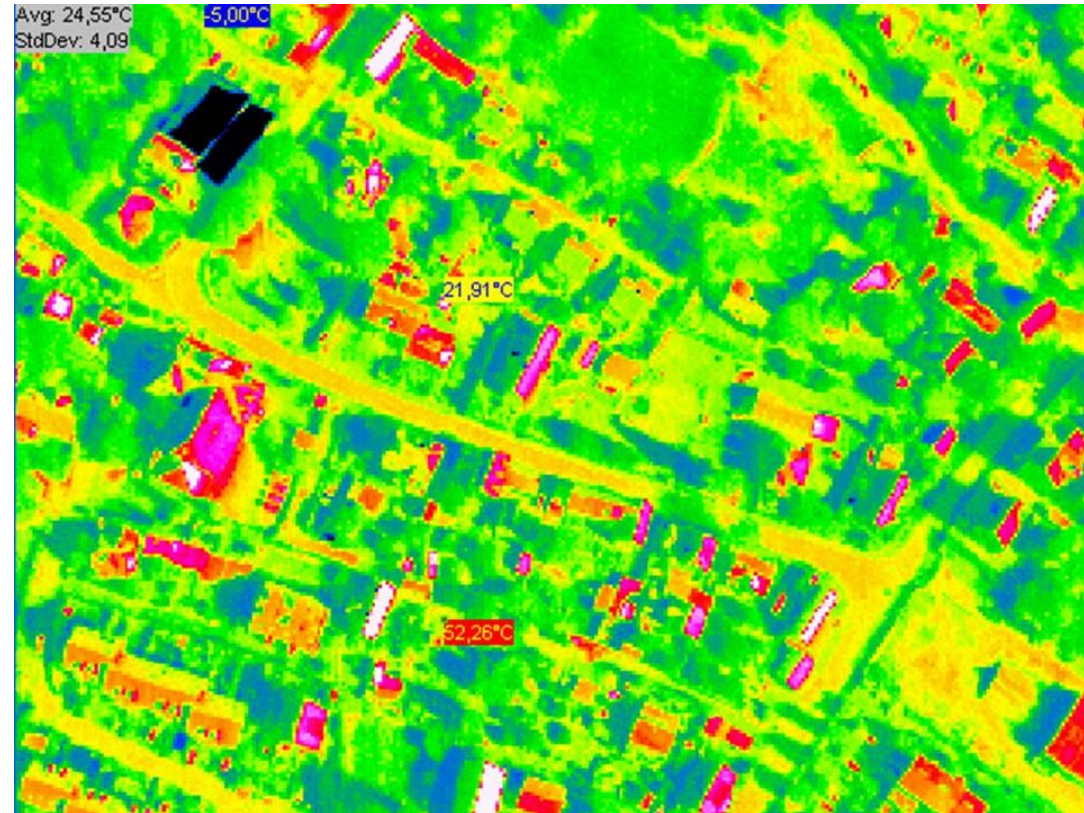



GFZ/DLR – Measurement and Processing Concept – Climate

Satellite data

Vorprozessierung

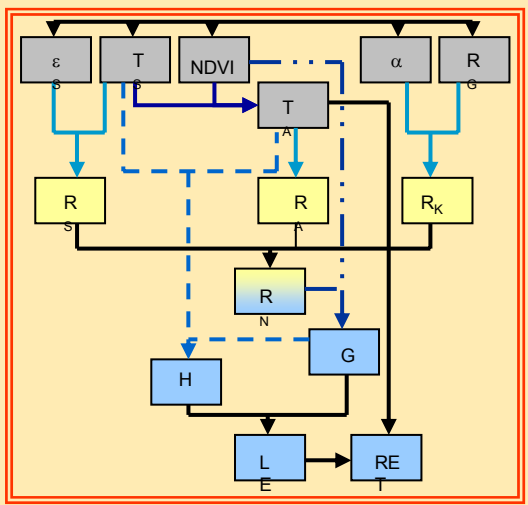

Nachprozessierung

Developing and Implementation of a operational processor for generation of remote sensing based climatologically relevant parameter maps such as air temperature and evapotranspiration for the CAL/VAL-Site DEMMIN

Climatological parameters



Plant parameters

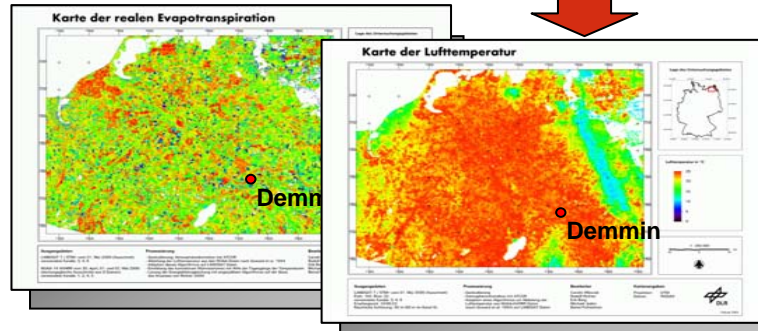
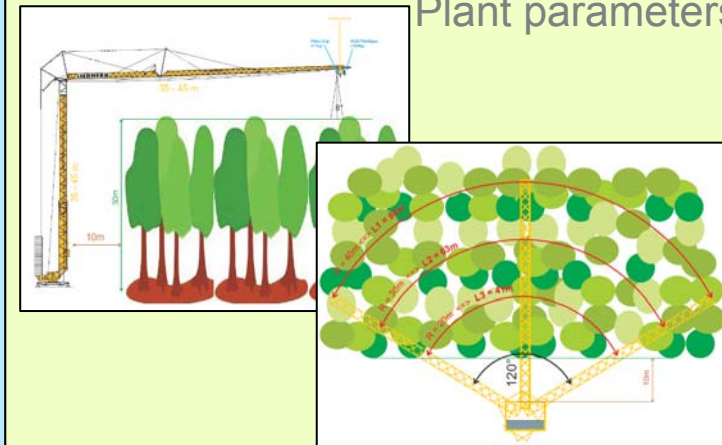

GFZ/DLR – Installation of a crane-/tower measurement-station for hyperspectral measurements in forests of CAL/VAL-Site DEMMIN
Intended Beginning of Operation: Spring 2011



Requirements on Spaceborne Sensors & Products

Research Institution	Optic		SAR		Passive Radar	
	Sensor	Data Product	Sensor	Data Product	Sensor	Data Product
German Aerospace Center <i>Microwaves and Radar Inst.;</i> <i>Earth Observation Center</i>	EnMAP (2015)	<i>biophysical,</i> <i>biochemical,</i> <i>geochemical</i> <i>variables</i>	TerraSAR-X TanDEM-X PALSAR Tandem-L (2017)	<i>land class</i> <i>map; change</i> <i>detection; soil</i> <i>moisture;</i> DEM	---	
UFZ Helmholtz Center for Environmental Research	SPOT	<i>land class</i> <i>map;</i> <i>vegetation</i> <i>cover</i>	TerraSAR-X Envisat	<i>land class</i> <i>map; ...</i>	---	
Forschungszentrum Jülich GmbH <i>Agrosphere Institute (IBG 3)</i>	ASTER SPOT (LANDSAT) Rapid Eye	<i>land cover</i> NDVI, DTM <i>impervious-</i> <i>ness</i>	ERS-2 RADARSAT-2 ALOS, SMAP (2014)	<i>soil moisture</i> (roughness)	SMOS, SMAP (2014)	<i>soil</i> <i>moisture</i>
Karlsruhe Institute of Technology	---					
Helmholtz Center Potsdam - German Research Center for Geosciences	EnMAP (2015) LANDSAT Rapid Eye Sentinel-2 (2012)	<i>Hydrological,</i> <i>biophysical,</i> <i>geochemical</i> <i>variables,</i> <i>Land class</i> <i>map</i>	---	---	---	

Germany's Radar Mission: *TanDEM-X*

TerraSAR-X add-on for
Digital Elevation Measurements

<i>DEMs</i>	<i>Spatial Resolution</i>	<i>Absolute Vertical Accuracy (90%)</i>	<i>Relative Vertical Accuracy (point-to-point in 1° cell, 90%)</i>
<i>DTED-1</i>	90m x 90m	< 30m	< 20m
<i>DTED-2</i>	30m x 30m	< 18m	< 12m
<i>TanDEM-X DEM</i>	12m x 12m	< 10m	< 2m
<i>HDEM</i>	6m x 6m	< 5m	< 0.8m

October Revolution Island, Russia

First TanDEM-X high resolution DEM
(pursuit monostatic mode):
vertical accuracy ~ 10 cm



16. Juli. 2010

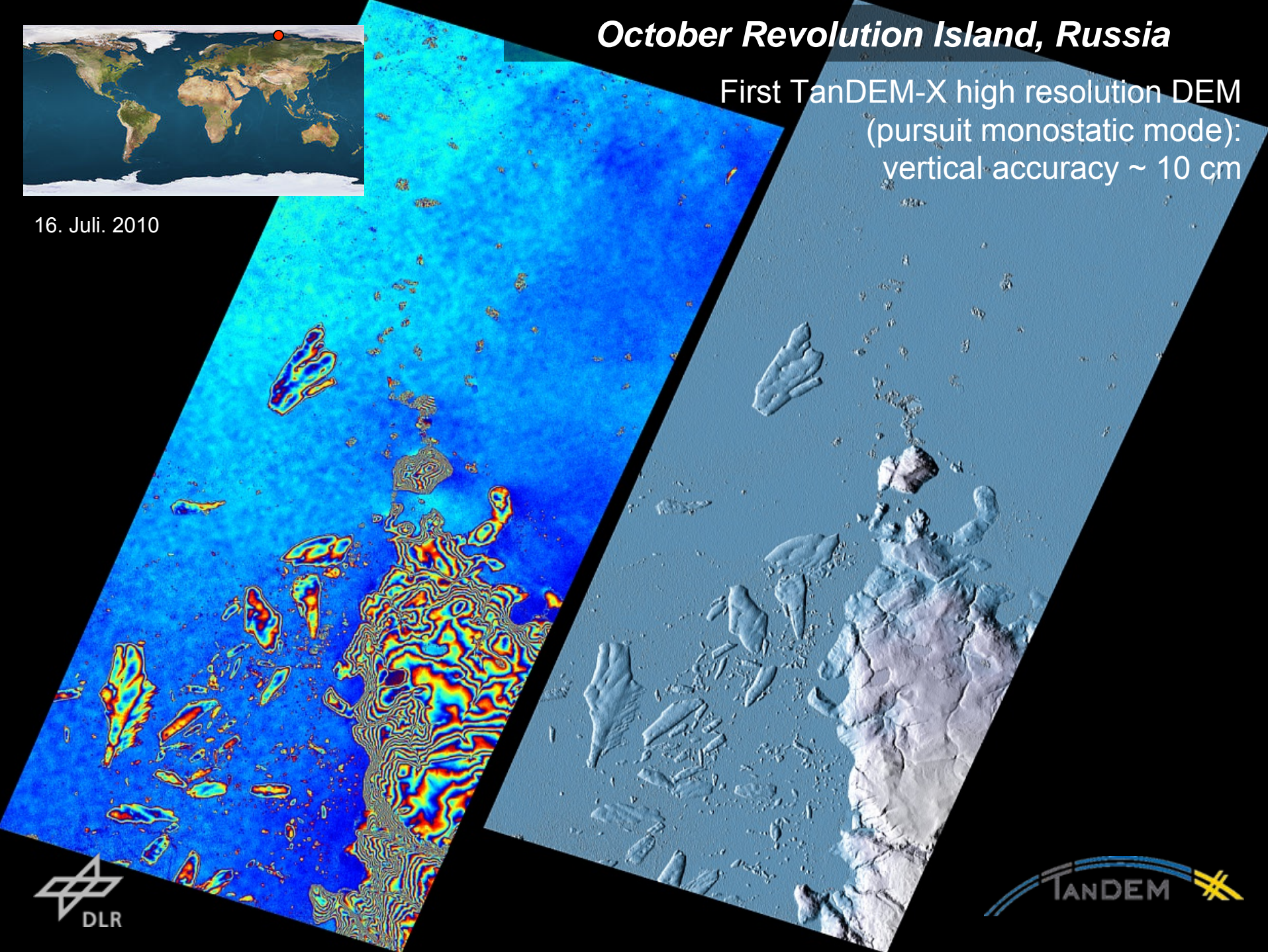

October Revolution Island Revisited

High Resolution DEMs at 79°N, 96°E

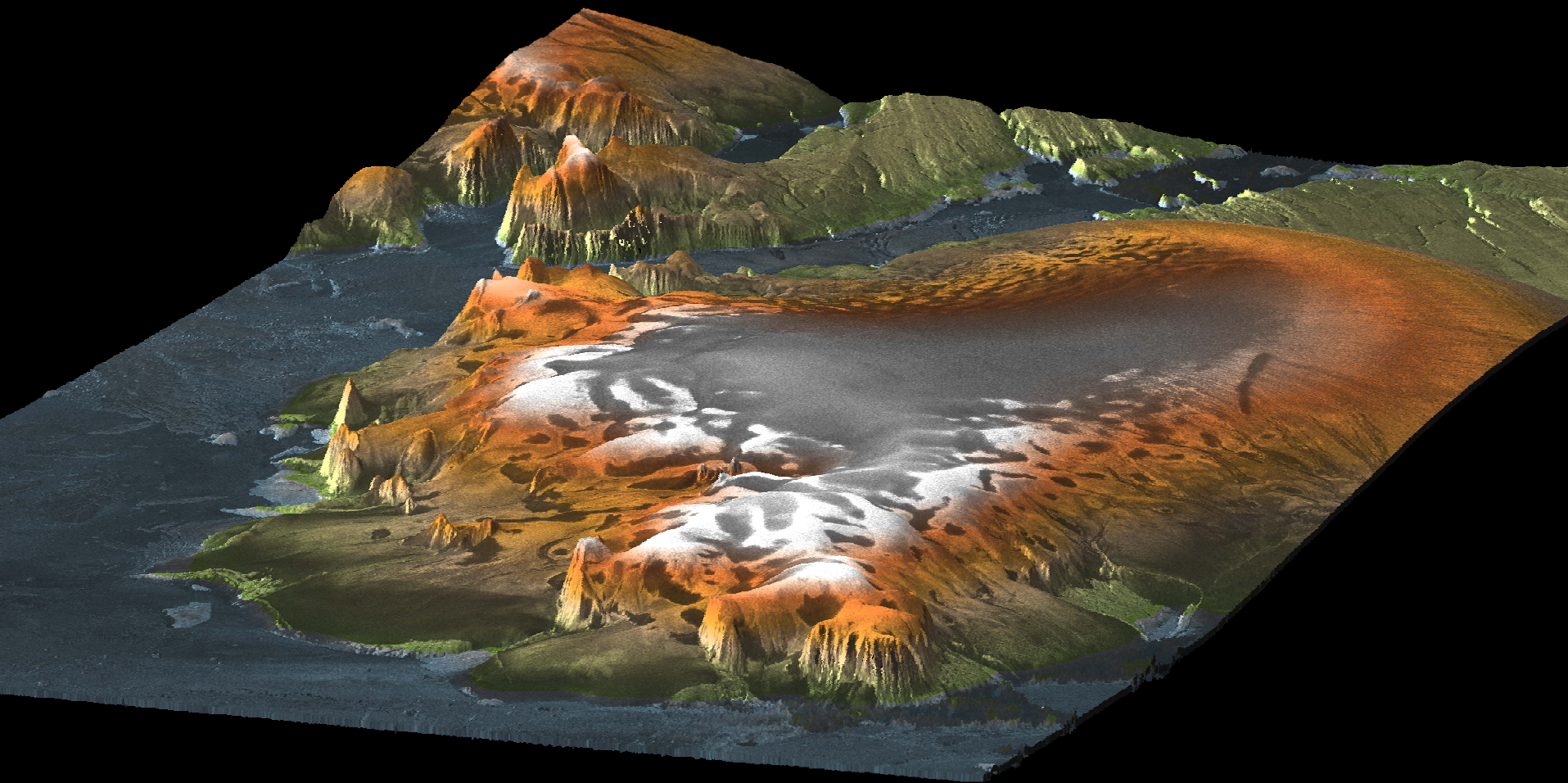



Secondary Mission Objectives: New Techniques Demonstration

Bistatic SAR Imaging

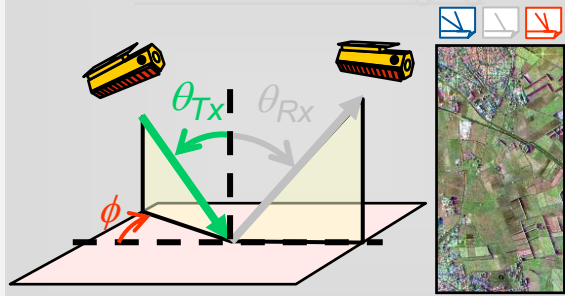

Polarimetric SAR Interferometry

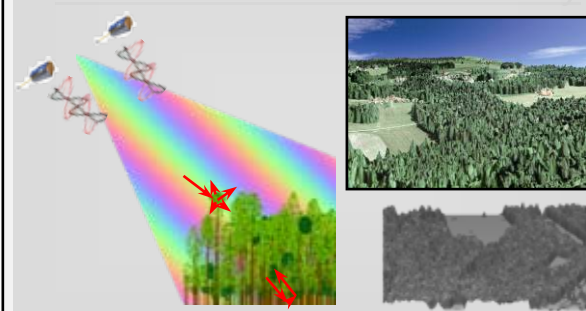

Along-Track Interferometry

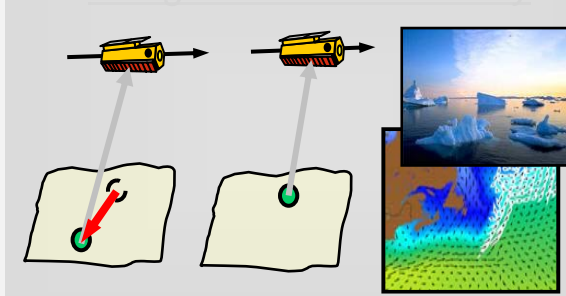

Ground Moving Target Indication

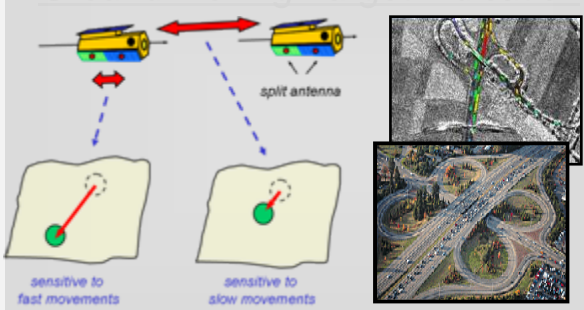

Double Differential Interferometry

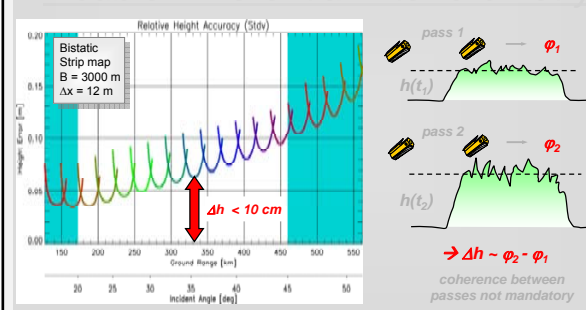

Digital Beamforming

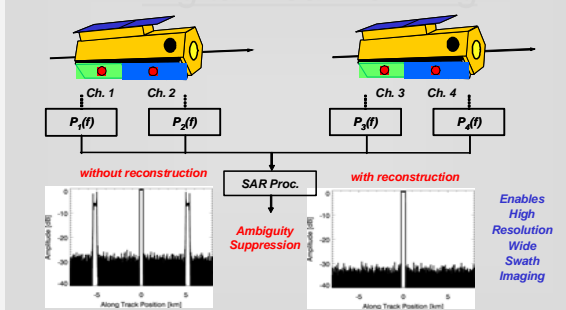

Super Resolution

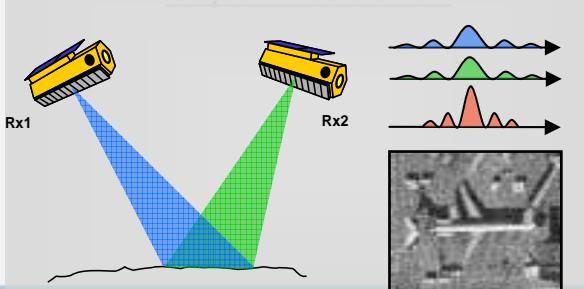

SAR Tomography

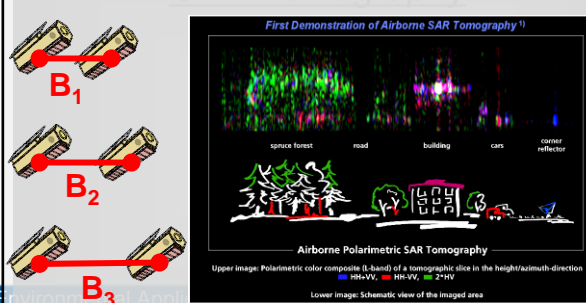

First Pol-InSAR Data Takes

Dual-Pol HH-VV Spotlight
Test Site Location: Russia
InSAR Mode: Monostatic
Temporal Baseline: 3sec
Spatial Baseline (\perp): 275m



Pol-InSAR

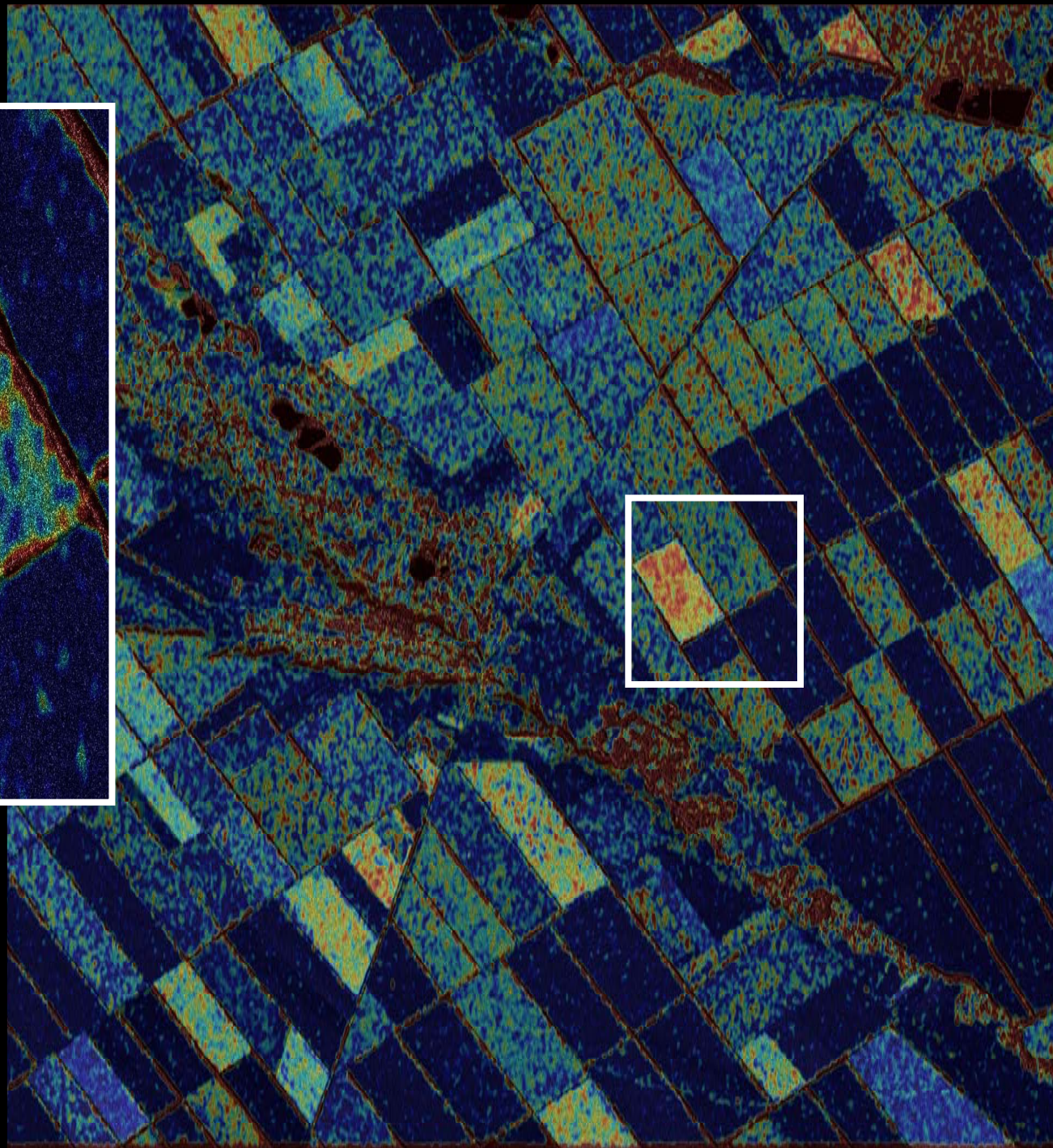
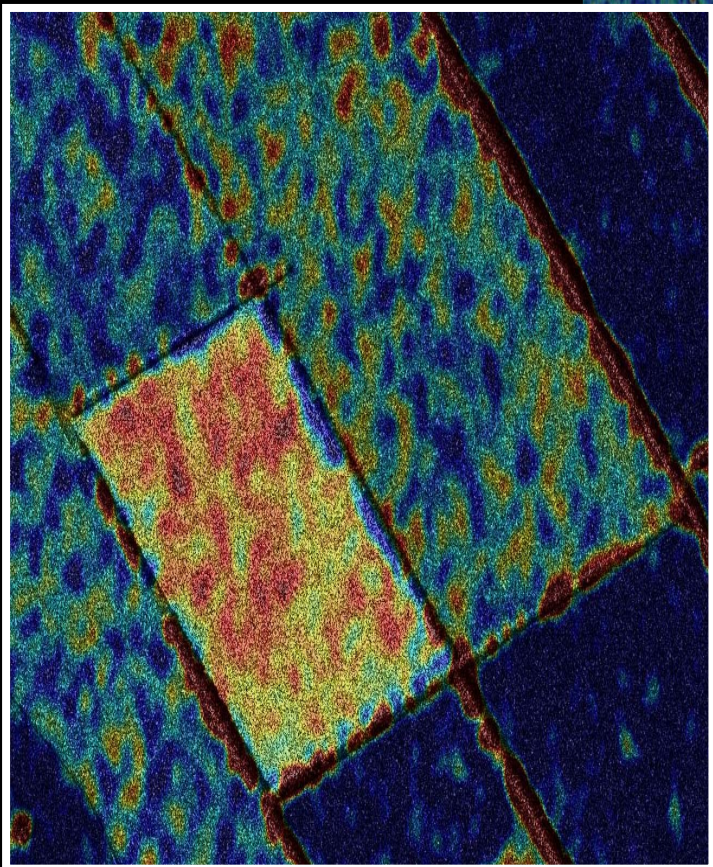

Phase difference in height [m]:



Tandem-L

Systematic monitoring of dynamic processes on the Earth surface



	<i>Produkte</i>	<i>Auflösung</i>	<i>Wiederholrate</i>
Biosphäre	<i>Waldhöhe</i>	<i>20 - 50 m</i>	<i>alle 16 Tage bis saisonal</i>
	<i>Wald gebundene Biomasse</i>		
	<i>Vertikale Waldstruktur</i>		
Geo-/ Lithosphäre	<i>Plattentektonik</i>	<i>5 - 100 m</i>	<i>wöchentlich</i>
	<i>Vulkanismus</i>		
	<i>Hangrutschungen</i>		
	<i>Deformationen</i>		
Kryo- & Hydrosphäre	<i>Gletscherbewegungen</i>	<i>50 - 500 m</i>	<i>wöchentlich</i>
	<i>Oberflächennahe Bodenfeuchte</i>		<i>wöchentlich</i>
	<i>Änderungen des Wasserspiegels</i>		<i>bei Bedarf</i>
	<i>Schnee Wasser-Äquivalent</i>		<i>saisonal</i>
	<i>Änderungen der Eisstruktur</i>		<i>saisonal</i>
	<i>Meeresströmungen</i>		<i>wöchentlich</i>
Global	<i>Digitale Gelände- & Oberflächenmodelle</i>	<i>20 - 50 m</i>	<i>jährlich</i>





Outlook

Discussion topic in the splinter meeting:

- Formulation and collection of requirements from the different CT's
- Availability of ground and air/space based instruments/sensors in 2011/2012
- Selection of test observatories for data collection
- Formulation of a rough campaign plan (ground, air, space borne)
- Assignment of contact persons for campaign organisation